

TUBES EN SILICONE, lisses

autoclavables, Couleur: transparent

D.I. (mm)	x	C	D.E. (mm)	REF	boîte
0,5	x	0,4	1,3	68-005-04	25 m
1,0	x	0,5	2,0	68-010-05	25 m
1,0	x	1,0	3,0	68-010-10	25 m
1,5	x	0,75	3,0	68-015-075	25 m
2,0	x	1,0	4,0	68-020-10	25 m
3,0	x	1,0	5,0	68-030-10	25 m
3,0	x	1,5	6,0	68-030-15	25 m
4,0	x	1,0	6,0	68-040-10	25 m
4,0	x	1,5	7,0	68-040-15	25 m
4,0	x	2,0	8,0	68-040-20	25 m
5,0	x	1,0	7,0	68-050-10	25 m
5,0	x	1,5	8,0	68-050-15	25 m
5,0	x	2,0	9,0	68-050-20	25 m
6,0	x	1,0	8,0	68-060-10	25 m
6,0	x	1,5	9,0	68-060-15	25 m
6,0	x	2,0	10,0	68-060-20	25 m
6,0	x	3,0	12,0	68-060-30	25 m
7,0	x	1,5	10,0	68-070-15	25 m
7,0	x	2,0	11,0	68-070-20	25 m
7,0	x	3,0	13,0	68-070-30	25 m
8,0	x	1,0	10,0	68-080-10	25 m
8,0	x	2,0	12,0	68-080-20	25 m
8,0	x	3,0	14,0	68-080-30	25 m
9,0	x	2,0	13,0	68-090-20	25 m
10,0	x	2,0	14,0	68-100-20	25 m
10,0	x	3,0	16,0	68-100-30	25 m
12,0	x	3,0	18,0	68-120-30	25 m
12,0	x	4,0	20,0	68-120-40	25 m
14,0	x	3,0	20,0	68-140-30	25 m
15,0	x	3,0	21,0	68-150-30	25 m
16,0	x	3,0	22,0	68-160-30	25 m
18,0	x	3,0	24,0	68-180-30	25 m
20,0	x	2,0	24,0	68-200-20	25 m
20,0	x	3,0	26,0	68-200-30	25 m
25,0	x	2,0	29,0	68-250-20	25 m
25,0	x	4,0	33,0	68-250-40	25 m

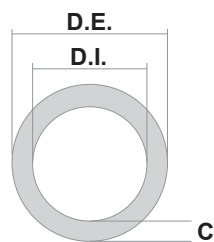

Pour toutes les autres tailles, nous contacter.

TUBES DE CONNEXION

pour tubes bronchiques à double lumière (Tube de Carlens)
autoclavables

Version	REF	boîte
avec pinces pour les tubes	60-80-200	5
sans pinces pour les tubes	60-80-201	5



ADAPTATEURS ENDO 15 MM

autoclavables



D.I. (mm)	Adaptateur Matériau: PSU	Adaptateur avec ailettes Matériau: PSU	Adaptateur avec connexion latérale Luer Lock pour prise de pression et capnographie stérile, Matériau: PMP	boîte
2,0	REF 44-2535-020	—	REF 44-3500-020-1	10
2,5	REF 44-2535-025	—	REF 44-3500-025-1	10
3,0	REF 44-2535-030	—	REF 44-3500-030-1	10
3,5	REF 44-2535-035	—	REF 44-3500-035-1	10
4,0	REF 44-2535-040	—	REF 44-3500-040-1	10
5,0	REF 44-2535-050	—	REF 44-3500-050-1	10
6,0	REF 44-2535-060	REF 44-2555-060	REF 44-3500-060-1	10
7,0	REF 44-2535-070	REF 44-2555-070	REF 44-3500-070-1	10
8,0	REF 44-2535-080	REF 44-2555-080	REF 44-3500-080-1	10
9,0	REF 44-2535-090	REF 44-2555-090	REF 44-3500-090-1	10
10,0	REF 44-2535-100	REF 44-2555-100	REF 44-3500-100-1	10

ASPIRATEUR MEKONIUM

usage unique, Matériau: PC

- connexion 15mm D.I. permet la connexion directe à la sonde ET pour aspirer les mucosités de la trachée
- la connexion conique permet de connecter une sonde d'aspiration standard pour aspirer les mucosités de la bouche et du pharynx
- pour tubes de 7-9 mm D.I.

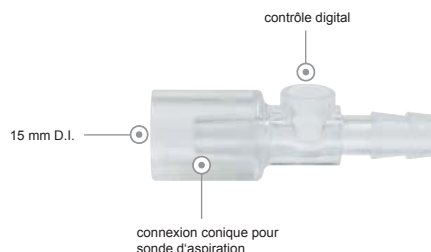

REF 49-30-000 boîte 10

RACCORDS, droits

autoclavables, Matériau: PSU



REF 60-30-002 boîte 10



REF 60-30-003 boîte 10



REF 60-30-005 boîte 10



REF 60-30-006 boîte 10



REF 60-40-002 boîte 10



REF 60-40-003 boîte 10



REF 60-40-005 boîte 10



REF 60-40-006 boîte 10

RACCORDS, droits

autoclavables, Matériau: PSU



REF 60-12-110 boîte 10



REF 60-12-300 boîte 10



REF 60-12-400 boîte 10



REF 60-50-002 boîte 10

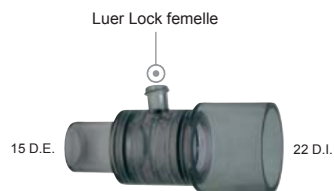

REF 60-12-501 boîte 10



REF 60-50-005 boîte 10



REF 60-50-003 boîte 10



REF 60-12-601 boîte 10

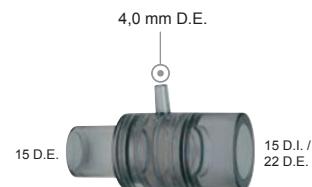

REF 60-12-602 boîte 10



REF 60-12-200 boîte 10

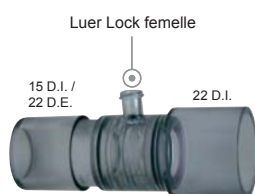

REF 60-12-201 boîte 10

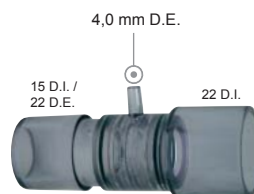

REF 60-12-202 boîte 10

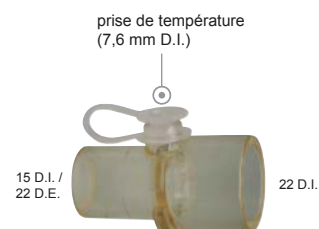

REF 60-12-203 boîte 10

RACCORD, droit

autoclavable, Matériau: Aluminium



pour Tube O₂

REF 60-71-002 boîte 10

RACCORDS AVEC VALVE ANTI-RETOUR, droits

autoclavables, Matériau: PSU

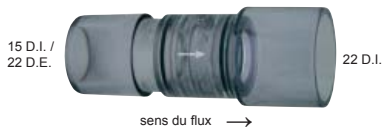

REF 60-12-277 boîte 10



REF 60-12-278 boîte 10

RACCORDS ORIENTABLES, droits

autoclavables, Matériau: PSU



REF 60-60-003 boîte 10



REF 60-70-004 boîte 10

RACCORDS, angulaires

autoclavables, Matériau: PSU



REF 60-65-002 boîte 10



REF 60-65-004 boîte 10



REF 60-65-005 boîte 10

RACCORDS, angulaires

autoclavables, Matériau: PSU



REF 60-12-000 boîte 10



REF 60-12-001 boîte 10



REF 60-12-002 boîte 10

RACCORDS ORIENTABLES, angulaires

autoclavables, Material: PSU



REF 60-60-002 boîte 10



REF 60-60-004 boîte 10

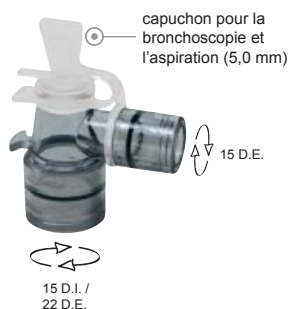

REF 60-60-010 boîte 10

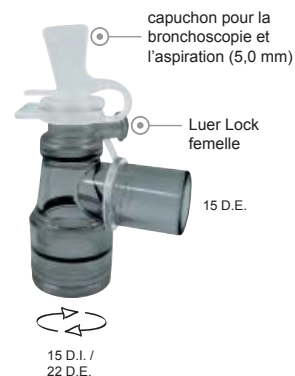

REF 60-60-006 boîte 10

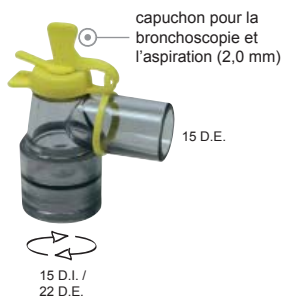

REF 60-60-305 boîte 10

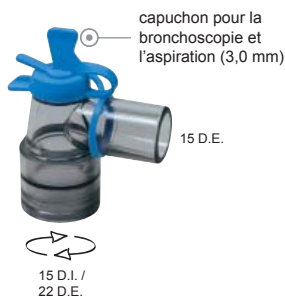

REF 60-60-205 boîte 10



REF 60-60-005 boîte 10

BROSU

Raccord avec valve permettant la bronchoscopie et l'aspiration sans fuite.

Lorsque le capuchon est ouvert la valve interne assure l'étanchéité du système.

- les gaz anesthésiques ne peuvent pas s'échapper
- pas de perte de pression (PEEP)
- le risque de contamination est minimisé lors de l'aspiration (alternative aux systèmes clos pour l'aspiration)
- assure l'étanchéité pendant et après la bronchoscopie

autoclavable, Matériau: PSU

Taille (port)	Code Couleur	pour		REF	boîte
		Sondes d'aspiration	Bronchoscopie		
2,0 mm	jaune	6 + 8 CH	≥ 2,0 mm D.E.	60-60-370	10
3,0 mm	bleu	10, 12, 14, 16 CH	≥ 3,0 mm D.E.	60-60-270	10
5,0 mm	transparent	18 CH	≥ 5,0 mm D.E.	60-60-070	10

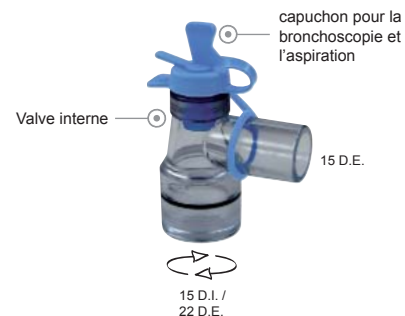

usage unique, Matériau: PC

Taille (port)	Code Couleur	pour		REF	boîte
		Sondes d'aspiration	Bronchoscopie		
2,0 mm	jaune	6 + 8 CH	≥ 2,0 mm D.E.	60-60-361-1	10
3,0 mm	bleu	10, 12, 14, 16 CH	≥ 3,0 mm D.E.	60-60-261-1	10
5,0 mm	transparent	18 CH	≥ 5,0 mm D.E.	60-60-061-1	10

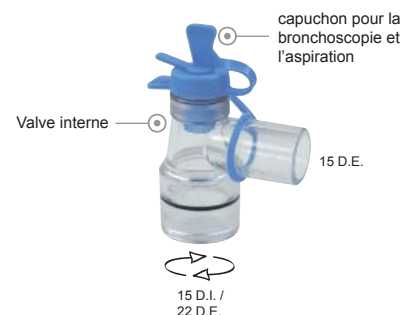

TUBE INHALER

Pour l'administration d'aérosols sur des patients intubés
autoclavable, Matériau: PSU

- compatible avec tous les aérosols
- application de l'aérosol pendant l'inspiration
- utilisation facile
- pas d'interruption de la ventilation
- aspiration possible (sonde CH 16 max.)

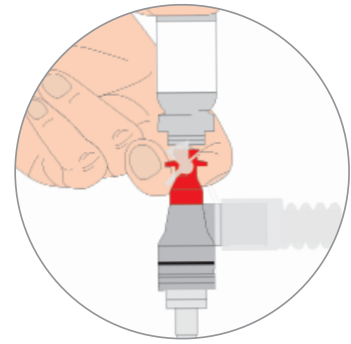

pour des aérosols avec
système de comptage ou
standard

REF 60-67-009 boîte 10



REF 60-65-009 boîte 10



REF 60-60-009 boîte 10



REF 60-60-209 boîte 10

TUBE INHALER (TUBES DE CONNEXION)

autoclavables, Matériau: Silicone (tube de connexion), PSU (raccord)

Longueur: 13 cm

REF 65-10-009 boîte 10

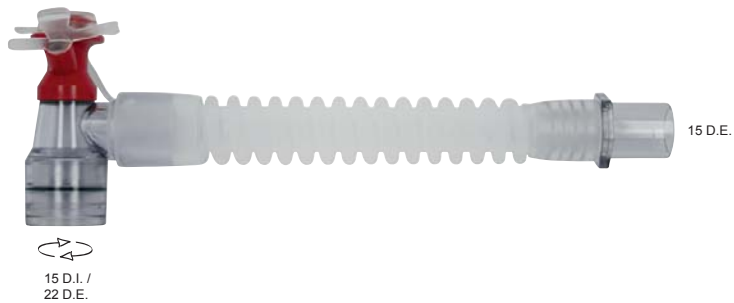

Longueur: 13 cm

REF 65-15-209 boîte 10

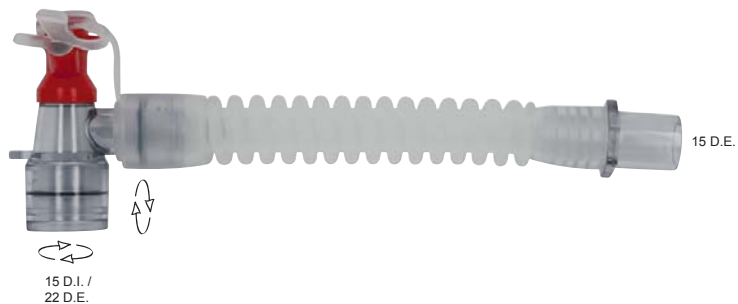

RACCORDS EN T

autoclavables, Matériau: PSU



REF 60-11-500 boîte 10



REF 60-11-503 boîte 10

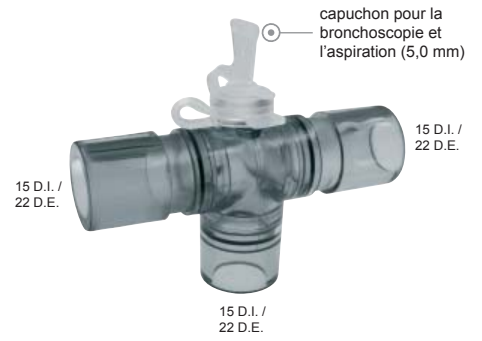

REF 60-11-510 boîte 10

RACCORDS EN Y, droits

autoclavables, Matériau: PSU

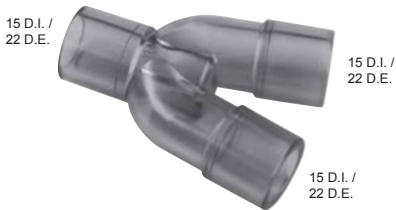

REF 60-11-200 boîte 10



REF 60-11-100 boîte 10

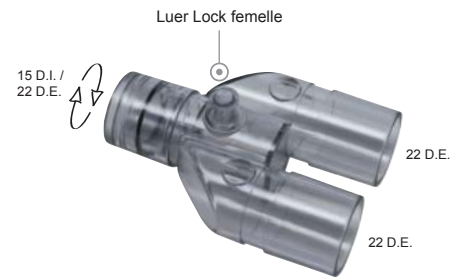

REF 60-11-101 boîte 10

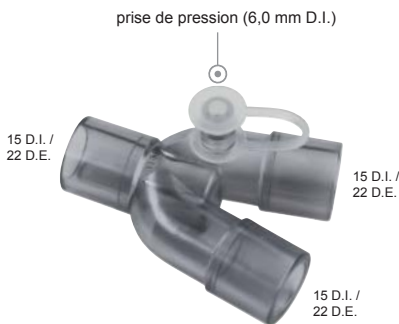

REF 60-11-202 boîte 10

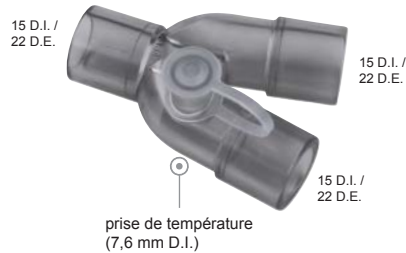

REF 60-11-203 boîte 10

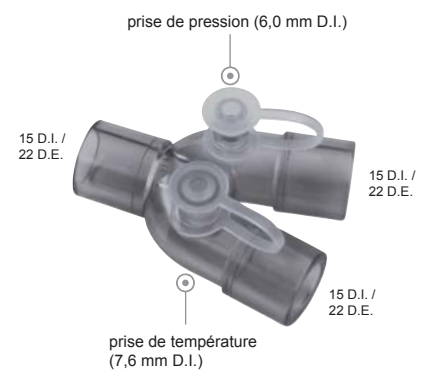

REF 60-11-204 boîte 10

RACCORDS EN Y, angulaires

autoclavables, Matériau: PSU



REF 60-11-300 Box 10



REF 60-11-302 Box 10

RACCORDS EN Y avec connexions orientables

autoclavables, Matériau: PSU



REF 60-11-400 boîte 10

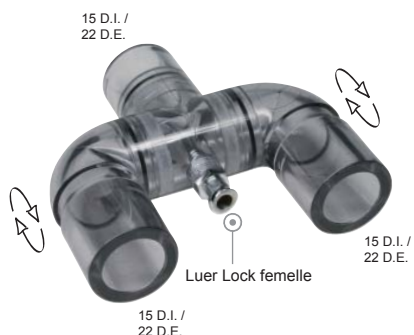

REF 60-11-420 boîte 10

TUBES DE CONNEXION, pour mesure du CO₂ et de la pression

usage unique

1,5 mm D.I. / 2,5 mm D.E.

Matériau: PVC / EVA / PE

Longueur	REF	boîte
150 cm	61-99-150	10
200 cm	61-99-200	10
300 cm	61-99-300	10

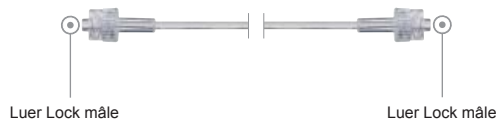

1,5 mm D.I. / 3,0 mm D.E.

Matériau: PUR

Longueur	REF	boîte
200 cm	61-95-200	10
300 cm	61-95-300	10



SET D'ADAPTATEURS

autoclavable, Matériau: PSU

composé de:

- 11 x Adaptateur Endo (REF 44-2535-020 – 44-2535-100)
- 2 x Raccord orientable, angulaire (REF 60-60-010, 60-65-004)
- 11 x Raccord, droit (REF 60-30-002, 60-30-003, 60-30-005, 60-40-002, 60-40-003, 60-40-005, 60-50-002, 60-50-003, 60-50-005, 60-12-110, 60-12-200)
- Raccord, angulaire 90° (REF 60-12-000)
- Pièce de désaccouplement (REF 60-60-999)

REF 60-91-001



TUBES DE CONNEXION (CATHETERS MOUNT)

autoclavables, Matériau: Silicone (tube de connexion), PSU (raccord)

Longueur: 13 cm	Longueur: 20 cm	boîte
REF 65-00-130	REF 65-00-200	10



Longueur: 16 cm	Longueur: 23 cm	boîte
REF 65-00-160	REF 64-00-230	10



Longueur: 13 cm	Longueur: 20 cm	boîte
REF 65-50-130	REF 65-50-200	10



Longueur: 13 cm	Longueur: 20 cm	boîte
REF 65-55-130	REF 65-55-200	10



Longueur: 16 cm	Longueur: 23 cm	boîte
REF 65-55-160	REF 64-55-230	10



Longueur: 13 cm	Longueur: 20 cm	boîte
REF 65-52-130	REF 65-52-200	10



Longueur: 13 cm	Longueur: 20 cm	boîte
REF 65-57-130	REF 65-57-200	10

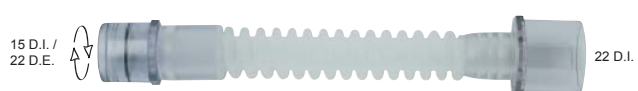

Longueur: 16 cm	Longueur: 23 cm	boîte
REF 65-57-160	REF 65-57-230	10



TUBES DE CONNEXION (CATHETERS MOUNT)

autoclavables, Matériau: Silicone (tube de connexion), PSU (raccord)

Longueur: 13 cm	Longueur: 20 cm	boîte
REF 65-60-130	REF 65-60-200	10

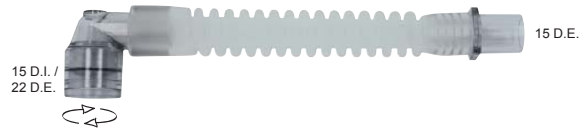

Longueur: 13 cm	Longueur: 20 cm	boîte
REF 65-80-130	REF 65-80-200	10

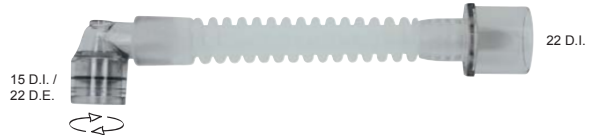

Longueur: 16 cm	Longueur: 23 cm	boîte
REF 65-80-160	REF 64-80-230	10



Longueur: 13 cm	Longueur: 20 cm	boîte
REF 65-65-130	REF 65-65-200	10

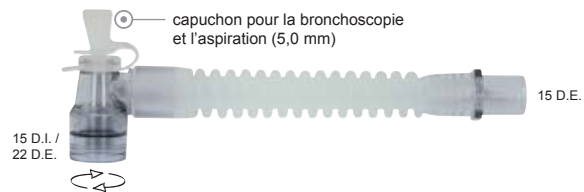

Longueur: 13 cm	Longueur: 20 cm	boîte
REF 65-85-130	REF 65-85-200	10

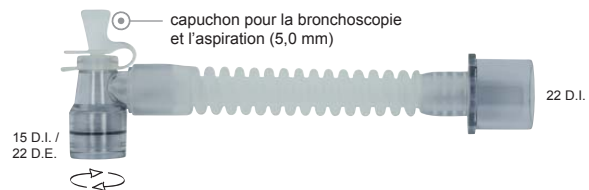

Longueur: 16 cm	Longueur: 23 cm	boîte
REF 65-85-160	REF 64-85-230	10

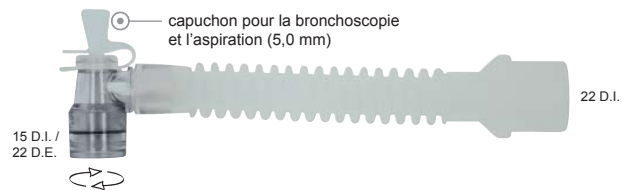

Longueur: 13 cm	Longueur: 20 cm	boîte
REF 65-68-130	REF 65-68-200	10

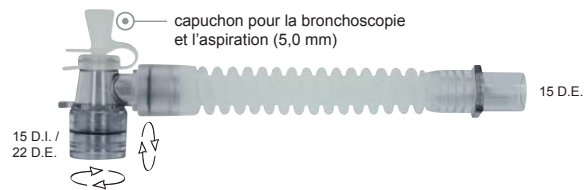

Longueur: 13 cm	Longueur: 20 cm	boîte
REF 65-88-130	REF 65-88-200	10

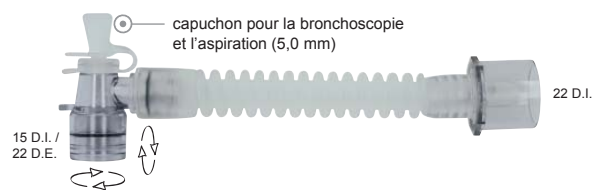

Longueur: 16 cm	Longueur: 23 cm	boîte
REF 65-88-160	REF 64-88-230	10

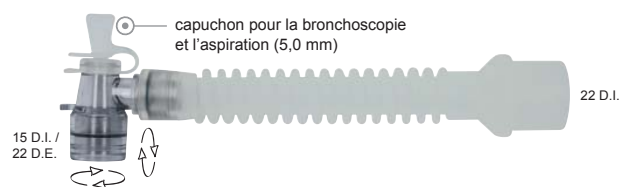

TUBES DE CONNEXION (CATHETERS MOUNT)

usage unique, stériles (seulement la longueur 15 cm)
Matériau: PVC (tube de connexion), PC (raccords)

Longueur: 15 cm	boîte	Longueur: 30 cm	Longueur: 45 cm	boîte
REF 60-50-150-1	25	REF 60-50-300	REF 60-50-450	10

Longueur: 15 cm	boîte	Longueur: 30 cm	Longueur: 45 cm	boîte
REF 60-55-150-1	25	REF 60-55-300	REF 60-55-450	10

Longueur: 15 cm	boîte	Longueur: 30 cm	Longueur: 45 cm	boîte
REF 60-52-150-1	25	REF 60-52-300	REF 60-52-450	10

Longueur: 15 cm	boîte	Longueur: 30 cm	Longueur: 45 cm	boîte
REF 60-57-150-1	25	REF 60-57-300	REF 60-57-450	10

Longueur: 15 cm	boîte	Longueur: 30 cm	Longueur: 45 cm	boîte
REF 60-60-150-1	25	REF 60-60-300	REF 60-60-450	10

Longueur: 15 cm	boîte	Longueur: 30 cm	Longueur: 45 cm	boîte
REF 60-80-150-1	25	REF 60-80-300	REF 60-80-450	10

Longueur: 15 cm	boîte	Longueur: 30 cm	Longueur: 45 cm	boîte
REF 60-65-150-1	25	REF 60-65-300	REF 60-65-450	10

Longueur: 15 cm	boîte	Longueur: 30 cm	Longueur: 45 cm	boîte
REF 60-85-150-1	25	REF 60-85-300	REF 60-85-450	10

Longueur: 15 cm	boîte	Longueur: 30 cm	Longueur: 45 cm	boîte
REF 60-68-150-1	25	REF 60-68-300	REF 60-68-450	10

Longueur: 15 cm	boîte	Longueur: 30 cm	Longueur: 45 cm	boîte
REF 60-88-150-1	25	REF 60-88-300	REF 60-88-450	10

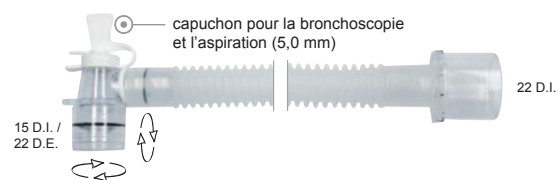
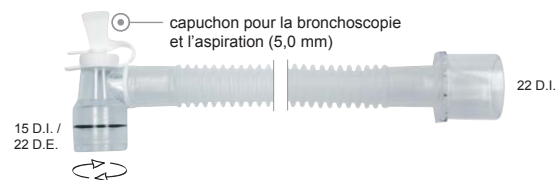
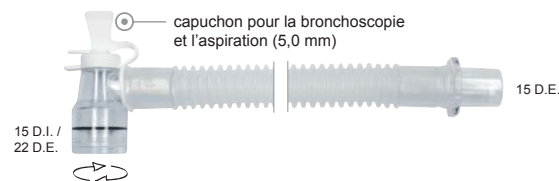
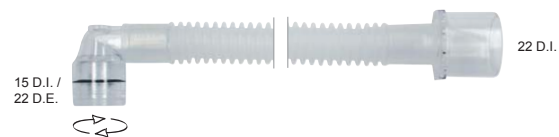
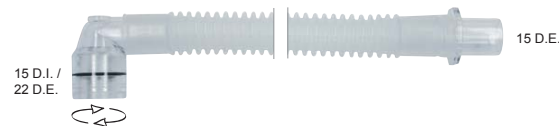
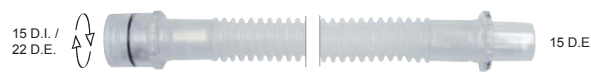
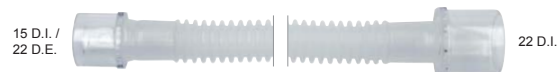

RACCORDS, droits

usage unique, Matériau: PC



REF 60-50-222 boîte 10



REF 60-50-333 boîte 10



REF 60-50-555 boîte 10



REF 60-60-333-1 boîte 10

RACCORDS ORIENTABLES, angulaires

usage unique, stérile
Matériau: PC



REF 60-60-222-1 boîte 10

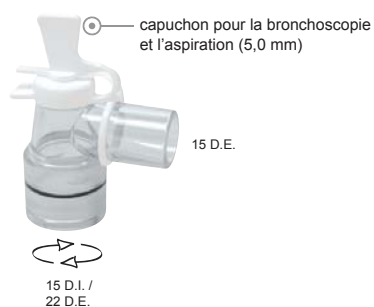

REF 60-60-555-1 boîte 10

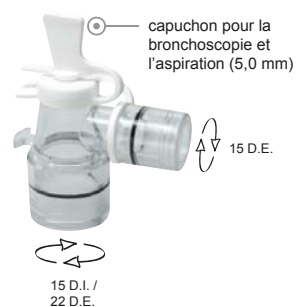

REF 60-60-111-1 boîte 10

RACCORDS, angulaires

usage unique, Matériau: PC



REF 60-13-000 boîte 10



REF 60-13-001 boîte 10

PIECE DE DESACCOUPLMENT

autoclavable, Matériau: PA

REF 60-60-999 boîte 10



RACCORDS EN Y PEDIATRIQUES, angulaires (version extra légère)

autoclavables, Matériau: PMP

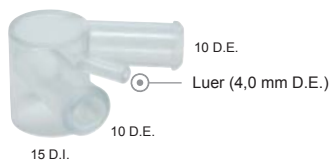

REF 60-20-300 boîte 10

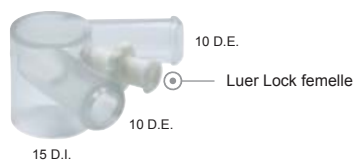

REF 60-20-301 boîte 10

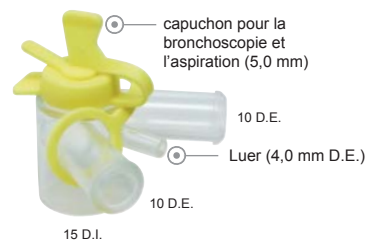

REF 60-20-400 boîte 10

RACCORDS EN Y PEDIATRIQUES, angulaires

autoclavables, Matériau: PSU



REF 60-20-600 boîte 10



REF 60-20-602 boîte 10

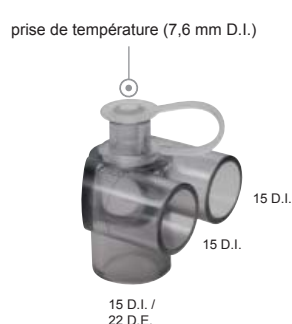

REF 60-20-603 boîte 10

RACCORDS EN Y PEDIATRIQUES, angulaires

autoclavables, Matériau: PSU



REF 60-20-100 boîte 10

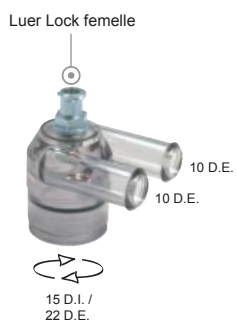

REF 60-20-101 boîte 10

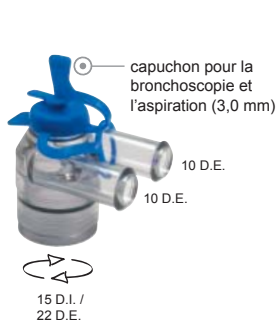

REF 60-20-200 boîte 10

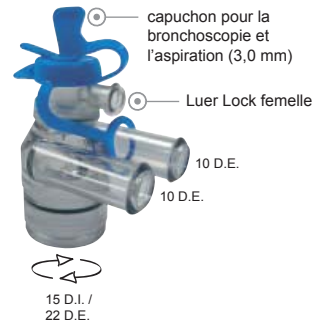

REF 60-20-201 boîte 10

RACCORDS EN Y PEDIATRIQUES, droits

autoclavables, Matériau: PSU



REF 60-20-500 boîte 10



REF 60-20-501 boîte 10

RACCORDS PEDIATRIQUES, droits

autoclavables, Matériau: PSU

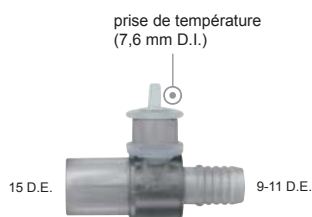

REF 60-20-703 boîte 10

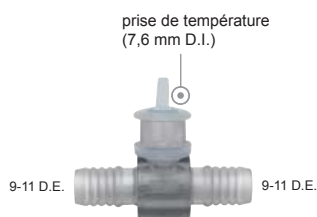

REF 60-20-713 boîte 10

TUBES DE CONNEXION EN Y PEDIATRIQUES

autoclavables, Matériau: Silicone (tube de connexion), PSU (raccords)

REF 65-20-100 boîte 10



REF 65-20-200 boîte 10



TUYAUX SPIRALES PEDIATRIQUES

autoclavables, Matériau: Silicone



Longueur: 9,0 cm

REF 65-00-090 boîte 10



Longueur: 10,5 cm

REF 65-00-105 boîte 10

CIRCUIT POUR NARCOSE PEDIATRIQUE

autoclavable

composé de:

- 2 x 9,0 mm Tube en silicone pour respirateurs REF 66-11-110
- 9,0 mm Tube en silicone pour respirateurs REF 66-12-110
- Raccord en Y, angulaire REF 60-20-100
- Ballon d'anesthésie en silicone 500 ml REF 66-00-011
- Raccord, droit REF 60-12-110

REF 62-11-200 boîte 1

